

Item description/product images

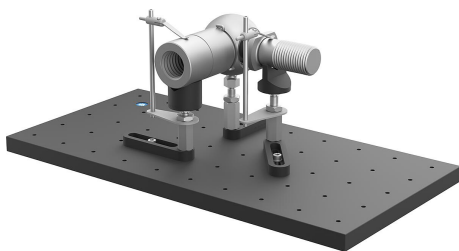
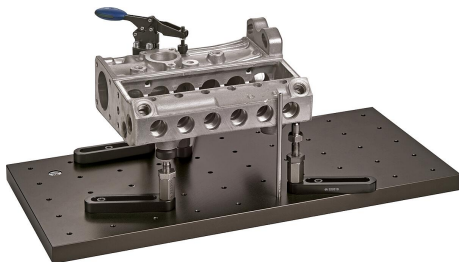
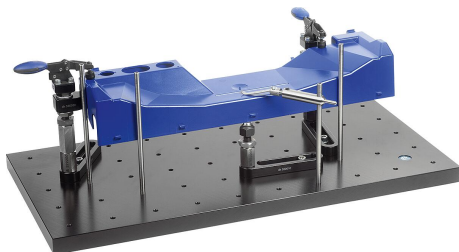
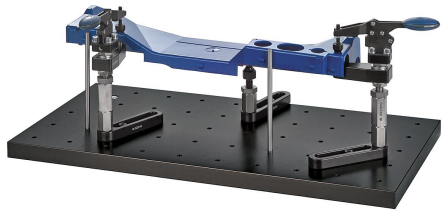
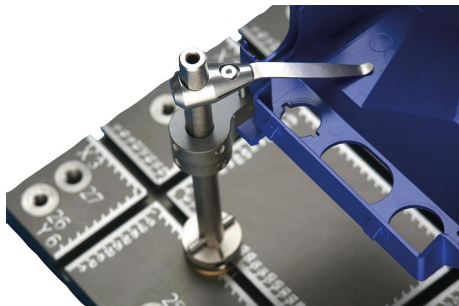

Description

Material:

Stainless steel 1.4301.

Version:

Bright.

Note:

Columns for mounting spring fingers / clamps 33260.

Form C has internal threads to extend the columns as desired.

Accessory:

Spring fingers, stainless steel 33260.

Mounting plate 33263.

Item description/product images

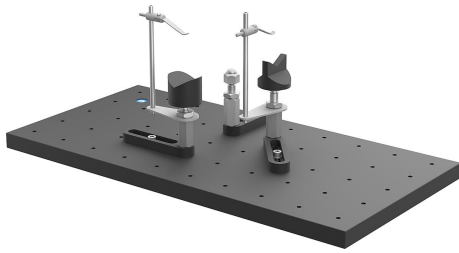

Drawings

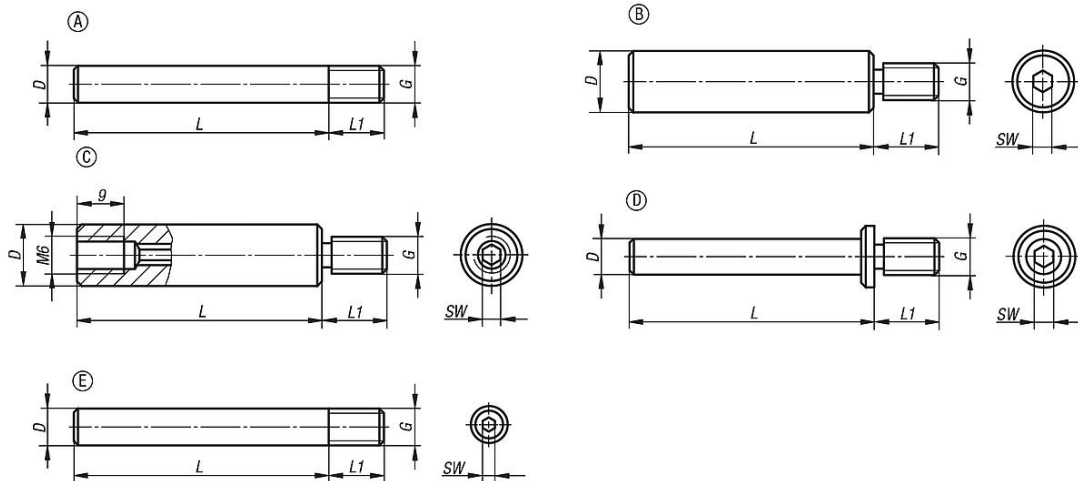

Overview of items

Order No.	Form	D	G	L	L1	SW
33262-0404X030	A	4	M4	30	5	-
33262-0404X050	A	4	M4	50	5	-
33262-1208X050	B	12	M8	50	11,5	4
33262-1208X100	B	12	M8	100	11,5	4
33262-1210X050	B	12	M10	50	11,5	4
33262-1210X100	B	12	M10	100	11,5	4
33262-1210X150	B	12	M10	150	11,5	4
33262-1206X050	C	12	M6	50	8	3
33262-1206X100	C	12	M6	100	8	3
33262-1206X150	C	12	M6	150	8	3
33262-0608X030	D	6	M8	30	10	3
33262-0608X050	D	6	M8	50	10	3
33262-0606X030	E	6	M6	30	8	3
33262-0606X050	E	6	M6	50	8	3
33262-0606X075	E	6	M6	75	8,5	3
33262-0606X100	E	6	M6	100	8,5	3
33262-0606X125	E	6	M6	125	8,5	3
33262-0606X150	E	6	M6	150	8,5	3